

CM INDUSTRIES
INC.

TRG 450W AUTO

Automatic, Water-Cooled, MIG Welding Gun



PARTS LIST

MADE IN USA

April 2020 v1

CM Industries, Inc.
505 Oakwood Rd. Lake Zurich, IL 60047
ph: 847-550-0033 fx: 847-550-0444
email: sales@cmindustries.com
www.cmindustries.com

PARTS LIST - Replacement Parts for TRG 450W AUTO - 450 Amps @ 80%

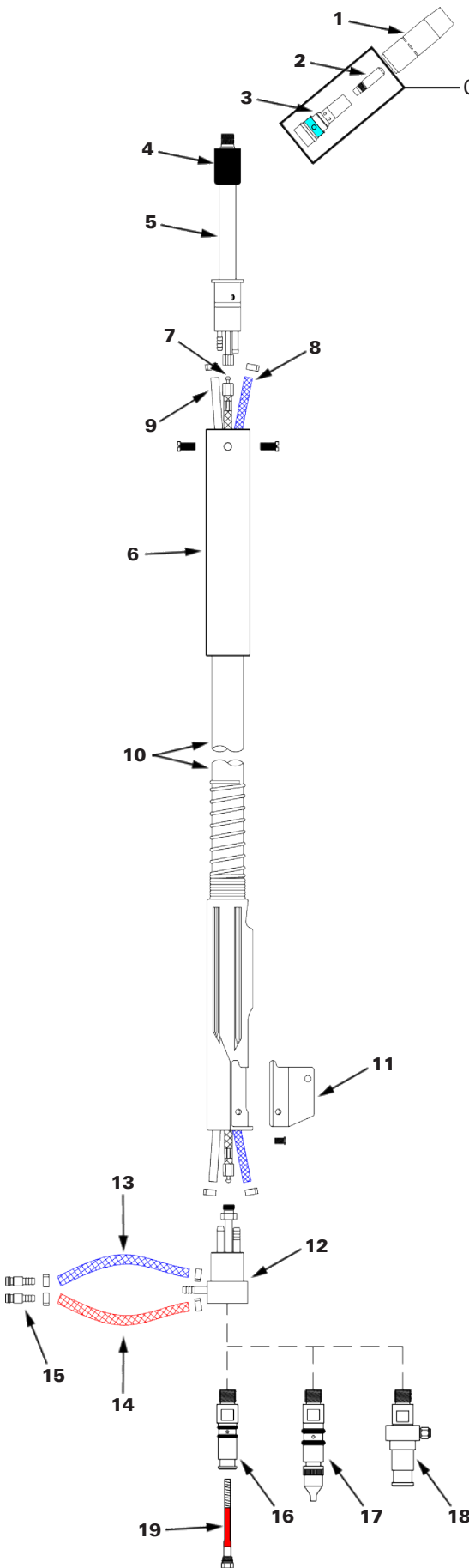

ITEM #	PART #	DESCRIPTION
TRG 450W AUTO		
1	R401-6-62	Nozzle, std.
	See <i>Nozzle Selection</i>	Nozzle, Optional Available
2	See <i>Contact Tip Selection</i>	Contact Tip, CMI Taper-LOCK™
	See <i>Contact Tip Selection</i>	Contact Tip, Tough Lock™
3	154-R505	Diffuser, H.D., CMI Taper-LOCK™
	154-R506	Diffuser, Tapered, CMI Taper-LOCK™
	R404-20	Diffuser, H.D., Tough Lock™
	R404-26	Diffuser, Dual-Tapered, Tough Lock™
4	R458-1	Neck Insulator
5	R455-180	Neck, 180°
	R455-45	Neck, 45°
	R455-60	Neck, 60°
6	R410-10	Front Housing
Items 7-10 are available in lengths of 4, 6, 8, 10, and 15 feet		
7	R659-xx	Power Cable
8	R656-xx	Water Hose, Blue
9	R657-xx	Conduit
10	R663-1-xx	Outer Cable Cover
11	R416-5	Control Housing Only
12	R664-1	Quick Connect Power Block Assembly
13	R658-1	Blue Water Line IN, 2'
14	R658	Red Water Line Out, 2'
15	350-52-001	Male Water Fitting
16	R664-12	Power Pin, Tweco® #4
17	R664-11-116	Power Pin, Miller®
	R214-116	Power Pin Cap, .035"-1/16"
	R214-332	Power Pin Cap, 5/64"-3/32"
18	R664-12	Power Pin, Lincoln® LN
19	See <i>Liner Selection</i>	Liner



Scan this QR Code to take you directly to the Technical Info page of cmindustries.com

Consumable Selection

Nozzles (Optional Available)

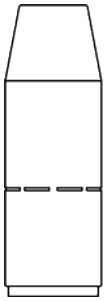

Light Duty	
R401-4-38	3/8", Flush Tip
R401-4-50	1/2", 1/8" Tip Recess
R401-4-62	5/8", 1/8" Tip Recess
R401-4-75	3/4", 1/8" Tip Recess
R401-8-62	5/8", 1/8" Tip Stickout, Short Arc
R401-42-50	1/2", Bottleneck, 1/8" Tip Recess
R401-48-50	1/2", Bottleneck, 1/8" Tip Stickout



Heavy Duty	
R401-5-50	1/2", 1/4" Tip Recess
R401-5-62	5/8", 1/4" Tip Recess
R401-5-75	3/4", 1/4" Tip Recess
R401-6-50	1/2", 1/8" Tip Recess
R401-6-62	5/8", 1/8" Tip Recess
R401-6-75	3/4", 1/8" Tip Recess
R401-7-62	5/8", 1/4" Tip Recess, Brass
R401-7-75	3/4", 1/4" Tip Recess, Brass
R401-7-87	7/8", 1/4" Tip Recess, Brass

Contact Tips

CM Industries Taper-LOCK™ Contact Tips



Heavy Duty	
155-1-030	0.030" (0.8mm)
155-1-035	0.035" (0.9mm)
155-1-040	0.040" (1.0mm)
155-1-045	0.045" (1.2mm)
155-1-364	3/64" (1.2mm)
155-1-052	0.052" (1.4mm)
155-1-062	0.062" (1.6mm)
155-1-1.8	0.071" (1.8mm)
155-1-564	5/64" (2.0mm)
155-1-332	3/32" (2.4mm)



Heavy Duty - Tapered	
155-2-030	0.030" (0.8mm)
155-2-035	0.035" (0.9mm)
155-2-040	0.040" (1.0mm)
155-2-045	0.045" (1.2mm)
155-2-364	3/64" (1.2mm)
155-2-052	0.052" (1.4mm)
155-2-062	0.062" (1.6mm)
155-2-1.8	0.071" (1.8mm)



X-tra Heavy Duty	
155-3-030	0.030" (0.8mm)
155-3-035	0.035" (0.9mm)
155-3-040	0.040" (1.0mm)
155-3-045	0.045" (1.2mm)
155-3-364	3/64" (1.2mm)
155-3-052	0.052" (1.4mm)
155-3-062	0.062" (1.6mm)
155-1-564	5/64" (2.0mm)
155-3-332	3/32" (2.4mm)
155-3-764	7/64" (2.8mm)

Comparable to Tregaskiss™ Tough Lock™ Contact Tips



Heavy Duty	
R403-20-30	0.030" (0.8mm)
R403-20-35	0.035" (0.9mm)
R403-20-1.0	0.040" (1.0mm)
R403-20-45	0.045" (1.2mm)
R403-20-364	3/64" (1.2mm)
R403-20-52	0.052" (1.4mm)
R403-20-116	1/16" (1.6mm)
R403-20-1.8	0.071" (1.8mm)
R403-20-564	5/64" (2.0mm)
R403-20-332	3/32" (2.4mm)



Heavy Duty - Tapered	
R403-21-30	0.030" (0.8mm)
R403-21-35	0.035" (0.9mm)
R403-21-1.0	0.040" (1.0mm)
R403-21-45	0.045" (1.2mm)
R403-21-52	0.052" (1.4mm)
R403-21-116	1/16" (1.6mm)



Extra Heavy Duty	
R603-20-45	0.045" (1.2mm)
R603-20-52	0.052" (1.4mm)
R603-20-116	1/16" (1.6mm)
R603-20-564	5/64" (2.0mm)
R603-20-332	3/32" (2.4mm)

Liners

Universal Conventional Liners

10' (3.05m) Gun Lengths

L3A-10	for 0.035" - 0.045" wire
L4A-10	for 0.045" - 1/16" wire

15' (4.57m) Gun Lengths

L1A-15	for 0.023" - 0.030" wire
L2A-15	for 0.030" - 0.035" wire
L3A-15	for 0.035" - 0.045" wire
L4A-15	for 0.045" - 1/16" wire
L6A-15	for 5/64" wire
L7A-15	for 3/32" wire
L8A-15	for 7/64" - 1/8" wire

25' (7.62m) Gun Lengths

L1A-25	for 0.023" - 0.030" wire
L2A-25	for 0.030" - 0.035" wire
L3A-25	for 0.035" - 0.045" wire
L4A-25	for 0.045" - 1/16" wire
L6A-25	for 5/64" wire
L7A-25	for 3/32" wire
L8A-25	for 7/64" - 1/8" wire

Conventional Liners

10' (3.05m) Gun Lengths

R415-35-10	for 0.035" - 0.045" wire
R415-116-10	for 0.045" - 1/16" wire

15' (4.57m) Gun Lengths

R415-30-15	for 0.030" - 0.035" wire
R415-35-15	for 0.035" - 0.045" wire
R415-116-15	for 0.045" - 1/16" wire
R415-564-15	for 5/64" wire
R415-332-15	for 3/32" wire

25' (7.62m) Gun Lengths

R415-30-25	for 0.030" - 0.035" wire
R415-35-25	for 0.035" - 0.045" wire
R415-116-25	for 0.045" - 1/16" wire
R415-564-25	for 5/64" wire
R415-332-25	for 3/32" wire

Conventional Liners for Aluminum

10' (3.05m) Gun Lengths

415-45-02	for 0.035" - 3/64" wire Polymer Liner
415-116-22	for 3/64" - 1/16" wire Polymer Liner

15' (4.57m) Gun Lengths

415-45-03	for 0.035" - 3/64" wire Polymer Liner
415-35-22	for 0.035" - 0.045" wire Steel Wrapped Nylon
415-116-2	for 0.045" - 1/16" wire Steel Wrapped Nylon
415-116-23	for 0.045" - 1/16" wire Polymer Liner

25' (7.62m) Gun Lengths

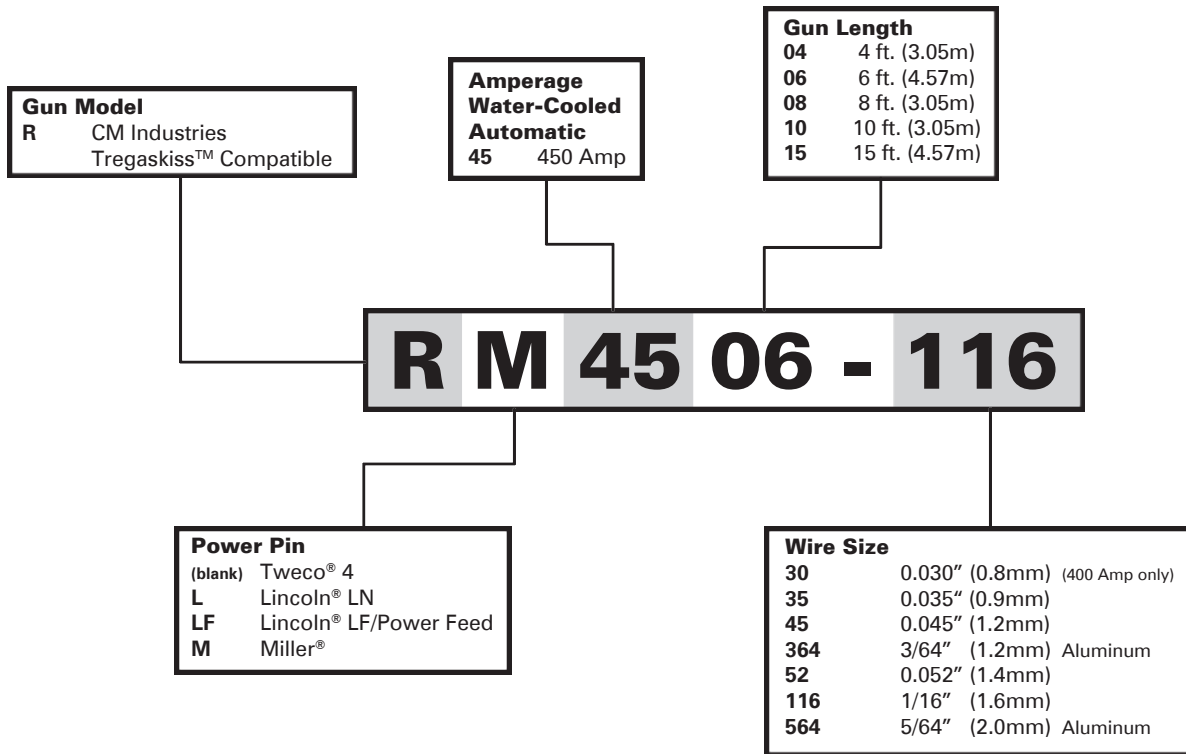

415-45-04	for 0.035" - 3/64" wire Polymer Liner
-----------	--

Ordering Information



SAFETY WARNINGS! READ BEFORE USE

 The symbols shown below are used throughout this manual to call attention to and identify possible hazards. When you see the symbol, watch out, and follow the related instructions to avoid the hazard. The safety information given below is only a summary of the more complete safety information found in the welding power source Owner's Manual.

 Read and follow all Safety Standards.
 Only qualified persons should install, operate, maintain, and repair this equipment. A qualified person is defined as one who, by possession of a recognized degree, certificate, or professional standing, or who by extensive knowledge, training and experience, has successfully demonstrated ability to solve or resolve problems relating to the subject matter, the work, or the project and has received safety training to recognize and avoid the hazards involved.

 During operation, keep everybody, especially children, away.

ELECTRIC SHOCK can kill.

- Always wear dry insulating gloves.
- Insulate yourself from work and ground.
- Do not touch live electrode or electrical parts.
- Replace worn, damaged, or cracked guns or cables.
- Turn off welding power source before changing contact tip or gun parts.
- Keep all covers and handle securely in place.

FUMES AND GASES can be hazardous.

- Keep your head out of the fumes.
- Ventilate area, or use breathing device. The recommended way to determine adequate ventilation is to sample for the composition and quantity of fumes and gases to which personnel are exposed.
- Read and understand the Safety Data Sheets (SDSs) and the manufacturer's instructions for adhesives, coatings, cleaners, consumables, coolants, degreasers, fluxes, and metals.

WELDING can cause fire or explosion.

- Do not weld near flammable material.
- Do not weld on containers that have held combustibles, or on closed containers such as tanks, drums, or pipes unless they are properly prepared according to AWS F4.1 and AWS A6.0 (see Safety Standards).
- Watch for fire; keep extinguisher nearby.
- Read and understand the Safety Data Sheets (SDSs) and the manufacturer's instructions for adhesives, coatings, cleaners, consumables, coolants, degreasers, fluxes, and metals.

HOT PARTS can burn.

- Allow gun to cool before touching.
- Do not touch hot metal.
- Protect hot metal from contact by others.



MOVING PARTS can injure.

- Keep away from moving parts.
- Keep away from pinch points such as drive rolls.



ARC RAYS can burn eyes and skin.

- Arc rays from the welding process produce intense visible and invisible (ultraviolet and infrared) rays that can burn eyes and skin. Sparks fly off from the weld.
- Wear an approved welding helmet fitted with a proper shade of filter lenses to protect your face and eyes from arc rays and sparks when welding or watching (see ANSI Z49.1 and Z87.1 listed in Safety Standards).
 - Wear approved safety glasses with side shields under your helmet.
 - Use protective screens or barriers to protect others from flash, glare and sparks; warn others not to watch the arc.
 - Wear body protection made from durable, flame-resistant material (leather, heavy cotton, wool). Body protection includes oil-free clothing such as leather gloves, heavy shirt, cuffless trousers, high shoes, and a cap.



BUILDUP OF GAS can injure or kill.

- Shut off compressed gas supply when not in use.
- Always ventilate confined spaces or use approved air-supplied respirator.



NOISE can damage hearing.

- Noise from some processes or equipment can damage hearing.
- Check for noise level limits exceeding those specified by OSHA.
 - Use approved ear plugs or ear muffs if noise level is high.
 - Warn others nearby about noise hazard.



WELDING WIRE can injure.

- Keep hands and body away from gun tip when trigger is pressed.

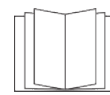

READ INSTRUCTIONS.

- Read and follow all labels and the Owner's Manual carefully before installing, operating, or servicing unit.
- Read the safety information at the beginning of the manual and in each section.
- Use only genuine replacement parts from the manufacturer.
- Perform installation, maintenance, and service according to the Owner's Manuals, industry standards, and national, state, and local codes.

CALIFORNIA PROPOSITION 65 WARNING

This product contains chemicals, including lead, known to the State of California to cause cancer, birth defects, or other reproductive harm. Wash hands after use. (California Health & Safety Code Section 25249.5)