

CM INDUSTRIES
INC.

BND 400-H & 600-F

Semi-Automatic, Air-Cooled, MIG Welding Gun

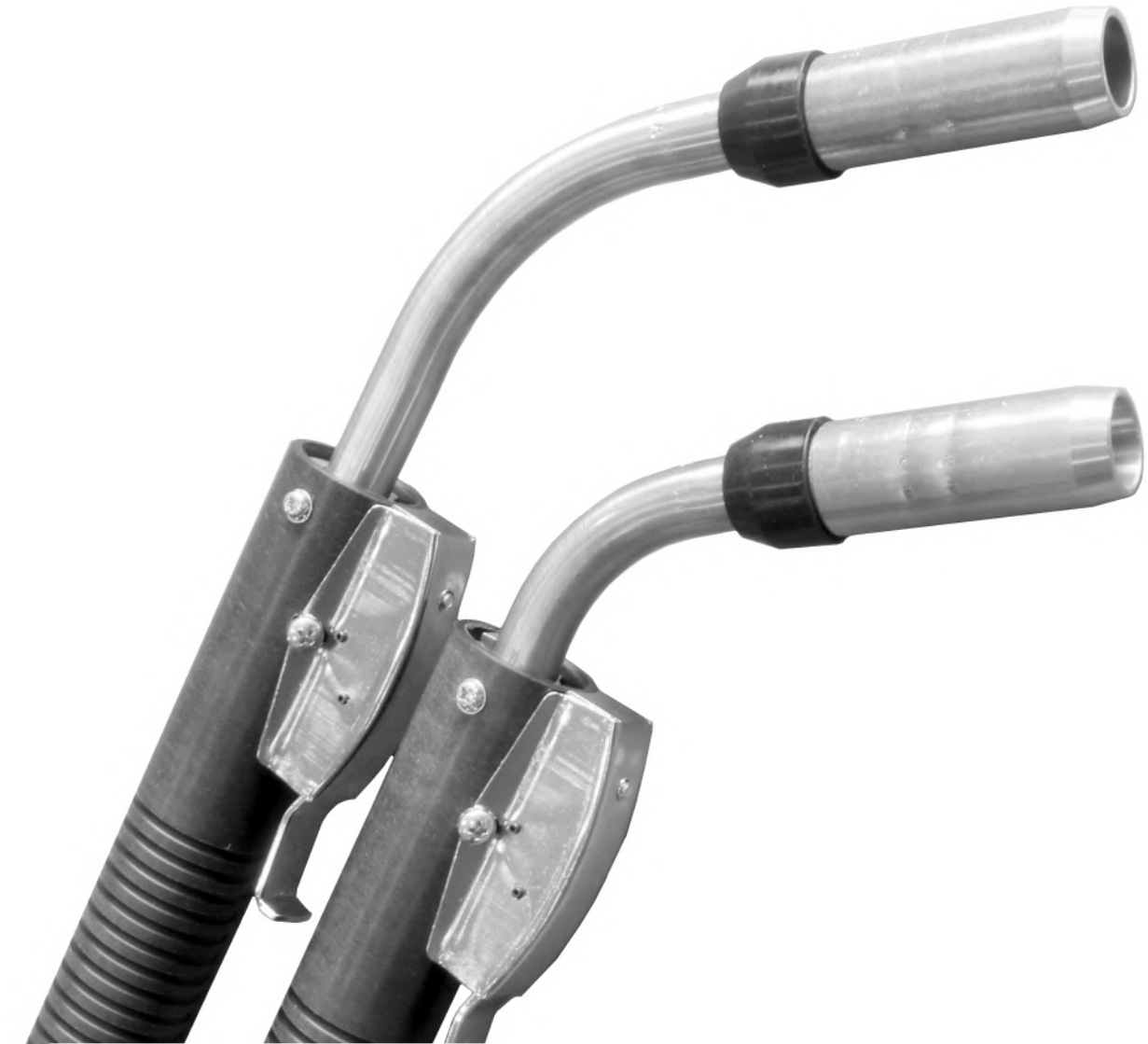

PARTS LIST

MADE IN USA

CM Industries, Inc.
505 Oakwood Rd. Lake Zurich, IL 60047
ph: 847-550-0033 fx: 847-550-0444
email: sales@cmindustries.com
www.cmindustries.com

October 2018 v1.1

PARTS LIST - Replacement Parts for BND 400-H & 600-F

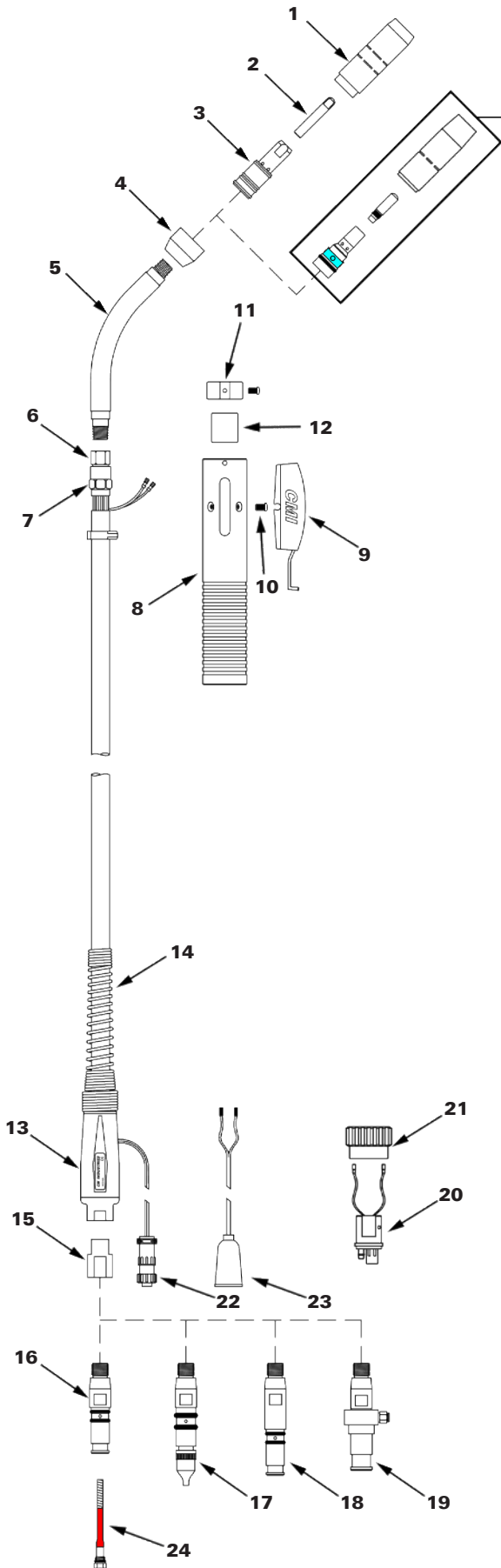

CM Taper-LOCK™ Performance Consumables

ITEM #	PART #		DESCRIPTION
	400-H	600-F	
1	B4491	B4591	Nozzle, 3/4" I.D.
	152-30-62C	152-30-75C	Nozzle, CMI Taper-LOCK™
	See Nozzle Selection		Optional Nozzles
2	See Contact Tip Selection		Contact Tip, Elliptical
	See Contact Tip Selection		Contact Tip, CMI Taper-LOCK™
3	B4435		Diffuser, Short Elliptical Tip (std. 400-H)
	B4635		Diffuser, Long Elliptical Tip (std. 600-F)
	154-B505		Diffuser, CMI Taper-LOCK™
4	B4423R		Neck Insulator
5	B5469	B4627	Neck
6	B4466	B4613	End Fitting
7	B4416	B4616	Cone Nut
8	B408		Handle Kit
9	B429		Trigger Switch Assy. (formally Part# B422)
10	B418		Trigger Switch Screw
11	B1518 B608		Spacer Kit Handle Screw
12	B4617		Spacer Insulator
13	B2520066		Strain Relief Kit
14	B2520041		Strain Relief Spring
15	B1010027R		Adapter Block
16	214		Power Pin, Tweco® #4
17	214-1		Power Pin, Miller®
	214-116		Power Pin Cap, .023"-1/16"
	214-332		Power Pin Cap, 5/64"-3/32"
18	214-25		Power Pin, Lincoln® PM & LF
19	214-7		Power Pin, Lincoln® LN
20	B5060CM		Euro Connector Plug
21	B4816		Euro Connector Nut
22	BGN2021		Control Plug, Miller® / Lincoln® PM
23	B4719		Control Plug, Lincoln® LN & LF
24	See Liner Selection		Liner



Scan this QR Code to take you directly to the Technical Info page of cmindustries.com

Consumable Selection

Nozzles (Optional Available)

Comparable to Bernard™ Nozzles



400-H & 600-F

B4491	Brass 3/4" I.D. (std. 400-H)
B4591	Copper 3/4" I.D. (std. 600-F)
B4492	Brass 9/16" I.D.
B4592	Copper 9/16" I.D.
B4495	Brass 5/8" I.D.
B4591HD	Copper, Heavy Duty 3/4" I.D.
B4592HD	Copper, Heavy Duty 9/16" I.D.

CM Industries Taper-LOCK™ Nozzles



Heavy Duty, Copper

152-30-50C	1/2" Bore, 1/8" Tip Recess
152-30-62C	5/8" Bore, 1/8" Tip Recess
152-31-562	5/8" Bore, 1/4" Tip Recess
152-32-62C	5/8" Bore, Flush Tip
152-33-62C	5/8" Bore, 1/8" Tip Stickout
152-34-62C	5/8" Bore, 1/4" Tip Stickout

Contact Tips

Comparable to Bernard™ Elliptical Contact Tips

Short



B7488	0.030" (0.8mm)
B7489	0.035" (0.9mm)
B7490	0.045" (1.2mm)
B7491	1/16" (1.6mm)
B7492	5/64" (2.0mm)
B7493	3/32" (2.4mm)
B7494	7/64" (2.8mm)
B7495	1/8" (3.2mm)
B7496	0.040" (1.0mm)
B7497	0.023" (0.6mm)
B7498	0.052" (1.4mm)

Long



B1588	0.030" (0.8mm)
B1589	0.035" (0.9mm)
B1590	0.045" (1.2mm)
B1591	1/16" (1.6mm)
B1592	5/64" (2.0mm)
B1593	3/32" (2.4mm)
B1594	7/64" (2.8mm)
B1595	1/8" (3.2mm)
B1596	0.040" (1.0mm)
B1597	0.023" (0.6mm)
B1598	0.052" (1.4mm)

CM Industries Taper-LOCK™ Contact Tips

Heavy Duty



155-1-030	0.030" (0.8mm)
155-1-035	0.035" (0.9mm)
155-1-040	0.040" (1.0mm)
155-1-045	.045" (1.2mm)
155-1-364	3/64" (1.2mm)
155-1-052	0.052" (1.4mm)
155-1-062	0.062" (1.6mm)
155-1-1.8	0.071" (1.8mm)
155-1-564	5/64" (2.0mm)
155-1-332	3/32" (2.4mm)
155-1-764	7/64" (2.8mm)

X-tra Heavy Duty



155-3-035	0.035" (0.9mm)
155-3-045	0.045" (1.2mm)
155-3-052	0.052" (1.4mm)
155-3-062	0.062" (1.6mm)
155-3-564	5/64" (2.0mm)
155-3-332	3/32" (2.4mm)
155-3-764	7/64" (2.8mm)

Liners

Universal Conventional Liners

10' (3.05m) Gun Lengths

L3A-10	for 0.035" - 0.045" wire
L4A-10	for 0.045" - 1/16" wire

15' (4.57m) Gun Lengths

L1A-15	for 0.023" - 0.030" wire
L2A-15	for 0.030" - 0.035" wire
L3A-15	for 0.035" - 0.045" wire
L4A-15	for 0.045" - 1/16" wire
L6A-15	for 5/64" wire
L7A-15	for 3/32" wire
L8A-15	for 7/64" - 1/8" wire

25' (7.62m) Gun Lengths

L1A-25	for 0.023" - 0.030" wire
L2A-25	for 0.030" - 0.035" wire
L3A-25	for 0.035" - 0.045" wire
L4A-25	for 0.045" - 1/16" wire
L6A-25	for 5/64" wire
L7A-25	for 3/32" wire
L8A-25	for 7/64" - 1/8" wire

Conventional Liners for Aluminum

10' (3.05m) Gun Lengths

415-45-02	for 0.035" - 3/64" wire Polymer Liner
415-116-22	for 3/64" - 1/16" wire Polymer Liner

15' (4.57m) Gun Lengths

415-45-03	for 0.035" - 3/64" wire Polymer Liner
415-35-2	for 0.035" - 0.045" wire Steel Wrapped Nylon
415-116-2	for 0.045" - 1/16" wire Steel Wrapped Nylon
415-116-23	for 0.045" - 1/16" wire Polymer Liner

25' (7.62m) Gun Lengths

415-45-04	for 0.035" - 3/64" wire Polymer Liner
------------------	--

Ordering Information

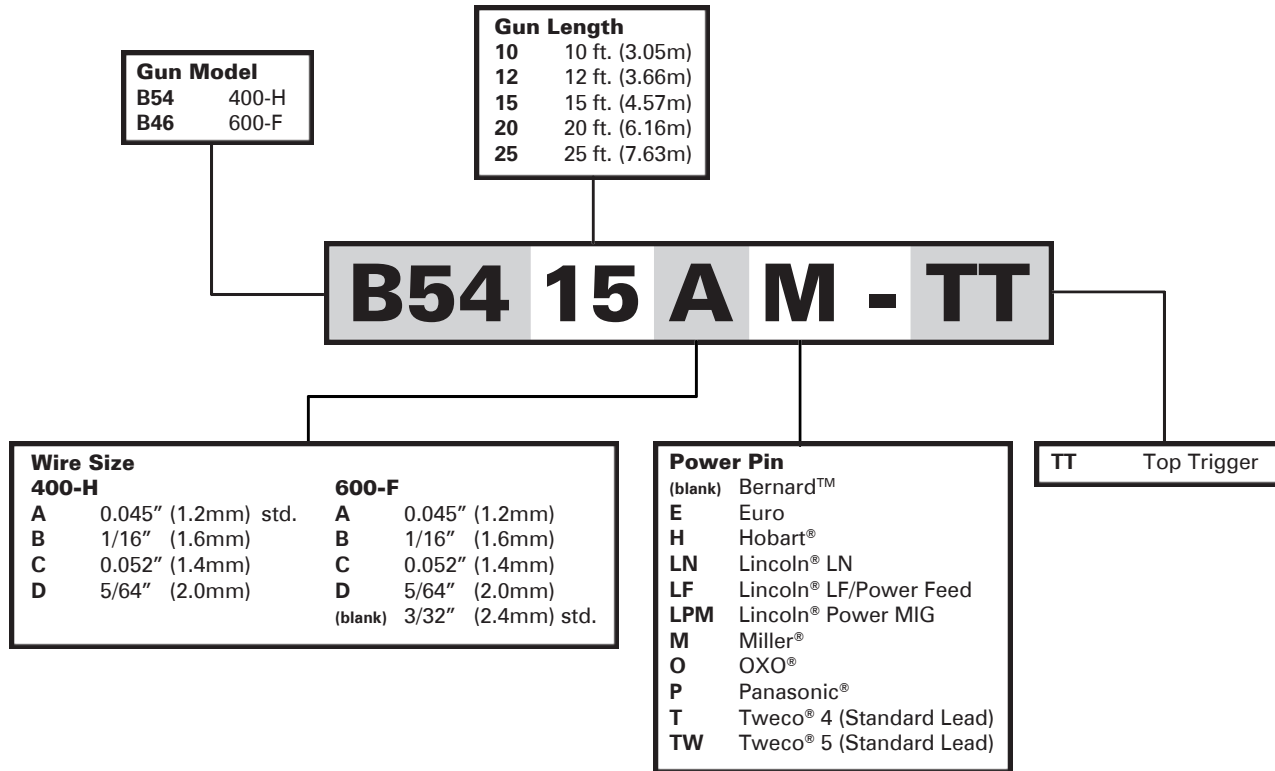



CM Industries, Inc. is in no way affiliated with above-named manufacturers. References to above-named parts, feeders, and part numbers are for your reference only.

SAFETY WARNINGS! READ BEFORE USE

 The symbols shown below are used throughout this manual to call attention to and identify possible hazards. When you see the symbol, watch out, and follow the related instructions to avoid the hazard. The safety information given below is only a summary of the more complete safety information found in the welding power source Owner's Manual.

 Read and follow all Safety Standards. Only qualified persons should install, operate, maintain, and repair this equipment. A qualified person is defined as one who, by possession of a recognized degree, certificate, or professional standing, or who by extensive knowledge, training and experience, has successfully demonstrated ability to solve or resolve problems relating to the subject matter, the work, or the project and has received safety training to recognize and avoid the hazards involved.

 During operation, keep everybody, especially children, away.

 **ELECTRIC SHOCK can kill.**

- Always wear dry insulating gloves.
- Insulate yourself from work and ground.
- Do not touch live electrode or electrical parts.
- Replace worn, damaged, or cracked guns or cables.
- Turn off welding power source before changing contact tip or gun parts.
- Keep all covers and handle securely in place.

 **FUMES AND GASES can be hazardous.**

- Keep your head out of the fumes.
- Ventilate area, or use breathing device. The recommended way to determine adequate ventilation is to sample for the composition and quantity of fumes and gases to which personnel are exposed.
- Read and understand the Safety Data Sheets (SDSs) and the manufacturer's instructions for adhesives, coatings, cleaners, consumables, coolants, degreasers, fluxes, and metals.

 **WELDING can cause fire or explosion.**

- Do not weld near flammable material.
- Do not weld on containers that have held combustibles, or on closed containers such as tanks, drums, or pipes unless they are properly prepared according to AWS F4.1 and AWS A6.0 (see Safety Standards).
- Watch for fire; keep extinguisher nearby.
- Read and understand the Safety Data Sheets (SDSs) and the manufacturer's instructions for adhesives, coatings, cleaners, consumables, coolants, degreasers, fluxes, and metals.

 **HOT PARTS can burn.**

- Allow gun to cool before touching.
- Do not touch hot metal.
- Protect hot metal from contact by others.



MOVING PARTS can injure.

- Keep away from moving parts.
- Keep away from pinch points such as drive rolls.



ARC RAYS can burn eyes and skin.

- Arc rays from the welding process produce intense visible and invisible (ultraviolet and infrared) rays that can burn eyes and skin. Sparks fly off from the weld.
- Wear an approved welding helmet fitted with a proper shade of filter lenses to protect your face and eyes from arc rays and sparks when welding or watching (see ANSI Z49.1 and Z87.1 listed in Safety Standards).
 - Wear approved safety glasses with side shields under your helmet.
 - Use protective screens or barriers to protect others from flash, glare and sparks; warn others not to watch the arc.
 - Wear body protection made from durable, flame-resistant material (leather, heavy cotton, wool). Body protection includes oil-free clothing such as leather gloves, heavy shirt, cuffless trousers, high shoes, and a cap.



BUILDUP OF GAS can injure or kill.

- Shut off compressed gas supply when not in use.
- Always ventilate confined spaces or use approved air-supplied respirator.



NOISE can damage hearing.

- Noise from some processes or equipment can damage hearing.
- Check for noise level limits exceeding those specified by OSHA.
 - Use approved ear plugs or ear muffs if noise level is high.
 - Warn others nearby about noise hazard.



WELDING WIRE can injure.

- Keep hands and body away from gun tip when trigger is pressed.

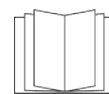

READ INSTRUCTIONS.

- Read and follow all labels and the Owner's Manual carefully before installing, operating, or servicing unit.
- Read the safety information at the beginning of the manual and in each section.
- Use only genuine replacement parts from the manufacturer.
 - Perform installation, maintenance, and service according to the Owner's Manuals, industry standards, and national, state, and local codes.

CALIFORNIA PROPOSITION 65 WARNING

This product contains chemicals, including lead, known to the State of California to cause cancer, birth defects, or other reproductive harm. Wash hands after use.
(California Health & Safety Code Section 25249.5)